

PLAY SAFE[®]

Individually
manufactured
sportsmouthguards



Playsafe sports-mouthguards

Play hard, play safe!

Protection

Safety first!

Prevention



PLAY SAFE®

Laminated sports-mouthguards,
two or three layers.

PLAY SAFE® triple

Prelaminated sports-mouthguards,
three layers.



Playsafe sports-mouthguards

PLAYSAFE®

4 u



Completely free individualisation of the Playsafe sports mouthguard types.

- Choose your preferred design and determine where it should be applied. Mostly at the visible surface during wearing. Because of the bite changing it is not recommended to apply designs at the occlusal surface.

- Erkodent needs the data of the design as .jpg or .pdf. The print will be effected immediately and sent by letter to the client.

- Please check our web page for further information.

www.erkodent.com



Dental injuries

1. Crown fracture

Demolition or chipping without damage to the pulp

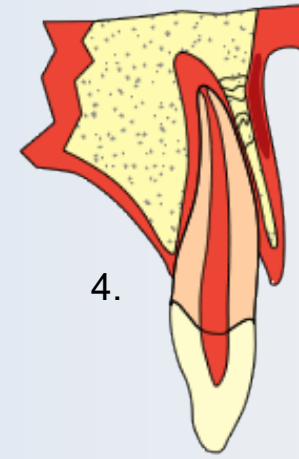
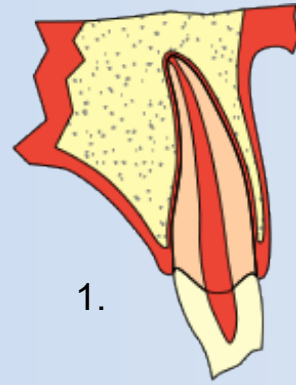

2. Crown fracture with opened dental pulp

Demolition or chipping without damage to the pulp

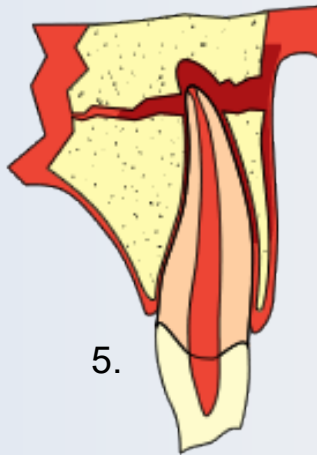
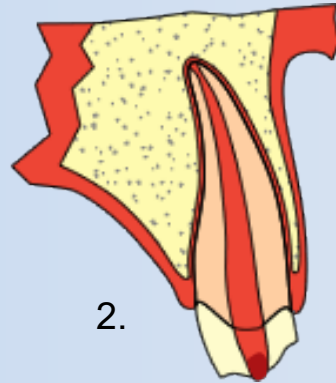

3. Root fracture

4. Extrusion injury

caused by a blow to the jaw bone

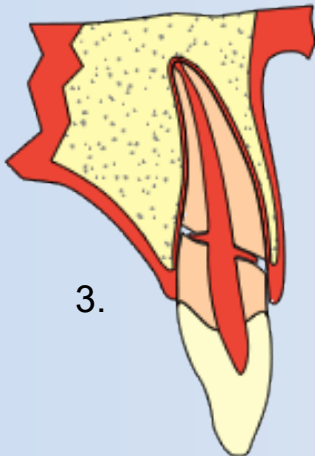

5. Jaw fracture

caused by extremely powerful impacts

(bottom right image: horseshoe)

Sports-mouthguards classification

1. preformed stock-mouthguard

Advantage:

- Cost

Disadvantage:

- Not adaptable
- Loose in the mouth
- Overload for prominent teeth
- Danger of breath obstruction

Nothing is better!!



1. preformed stock-mouthguard

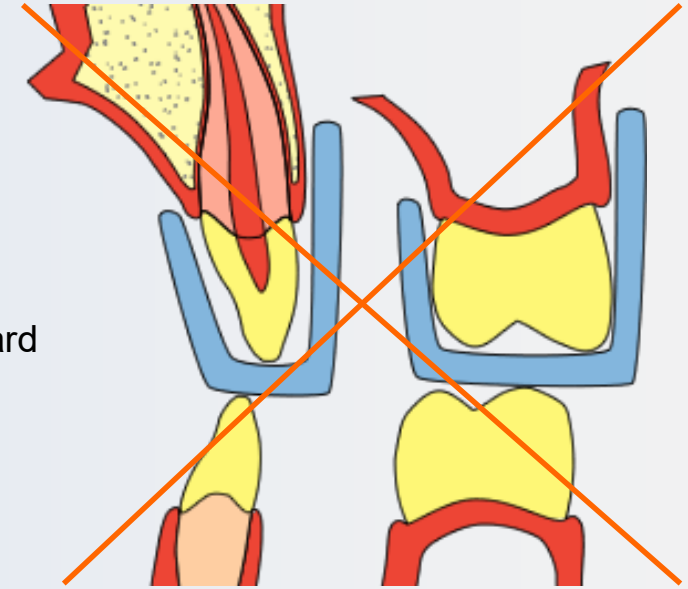

2. boil & bite mouthguard

Advantage:

- Cost
- Easy to get
- **Disadvantage:**
- Loose in the mouth
- Not enough occlusal thickness (bitten through while adapting)
- Only absorption, no power distribution

Better than nothing



2. Boil & bite mouthguard

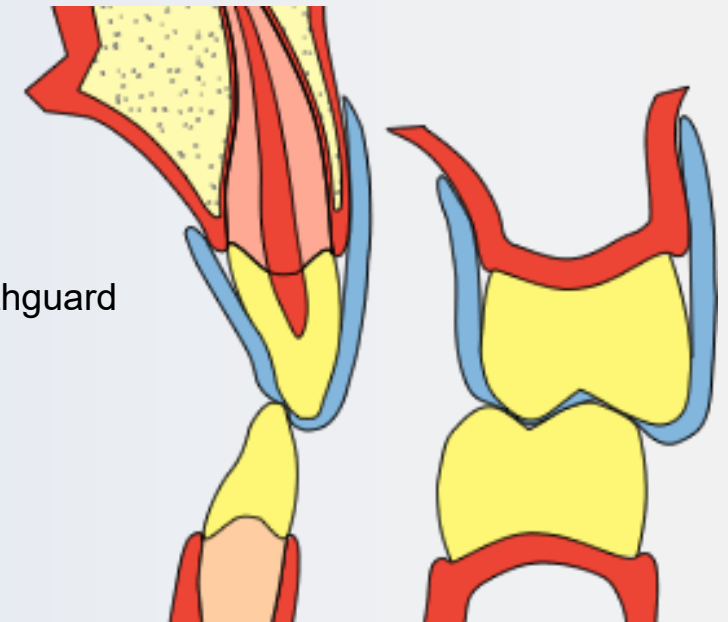

Sports-mouthguards classification

3. lab-made, individualized single-layer mouthguard

Advantage:

- Good fit
- Power absorption and distribution

Disadvantage:

- Not enough incisal thickness
- Limited power distribution
- Cost
- Availability



1. lab-made, individualized single-layer mouthguard

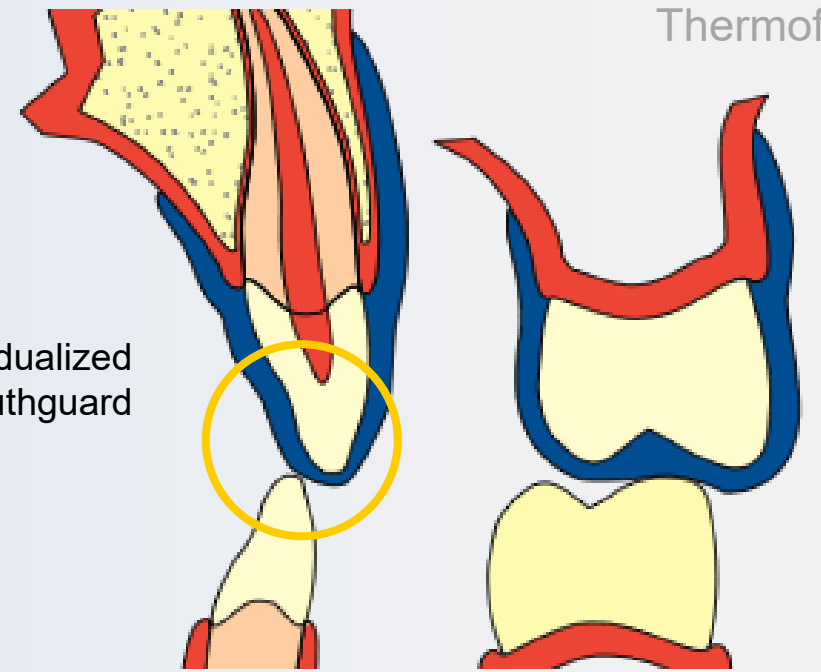

4. lab-made, individualized, laminated mouthguard

Advantage:

- Good fit
- High power absorption and distribution
- Best material proportion
- Can be reinforced
- Can be readapted(hot water)

Disadvantage:

- Cost
- Availability

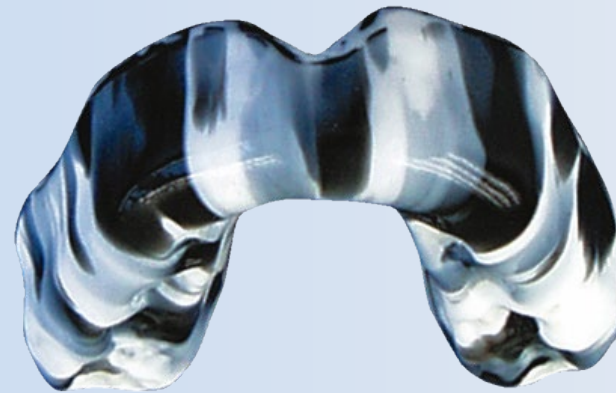

2. lab-made, individualized, laminated mouthguard

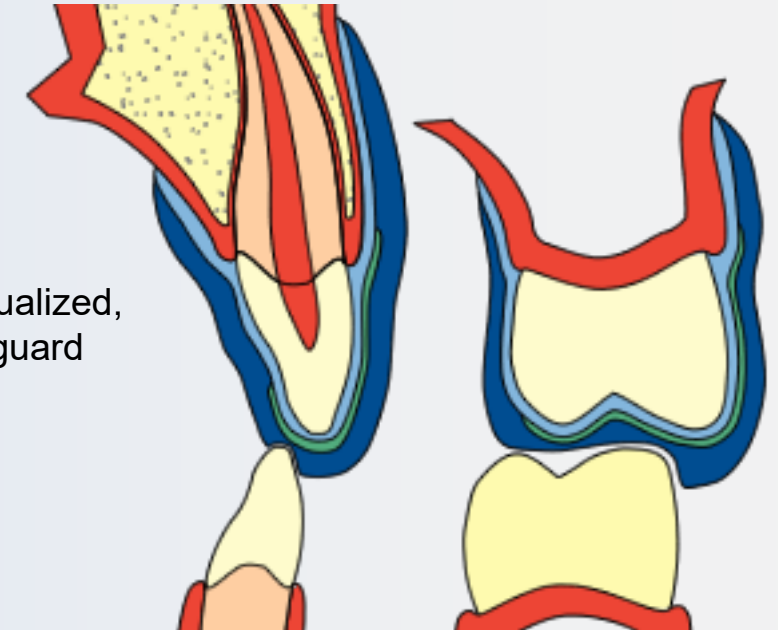

Sports-mouthguard extension

A Playsafe mouthguard covers the jaw bone as far as possible (a).

It covers the teeth including the first molar (b).

The bite opening should be 4 – 5 mm at the incisal point (c).

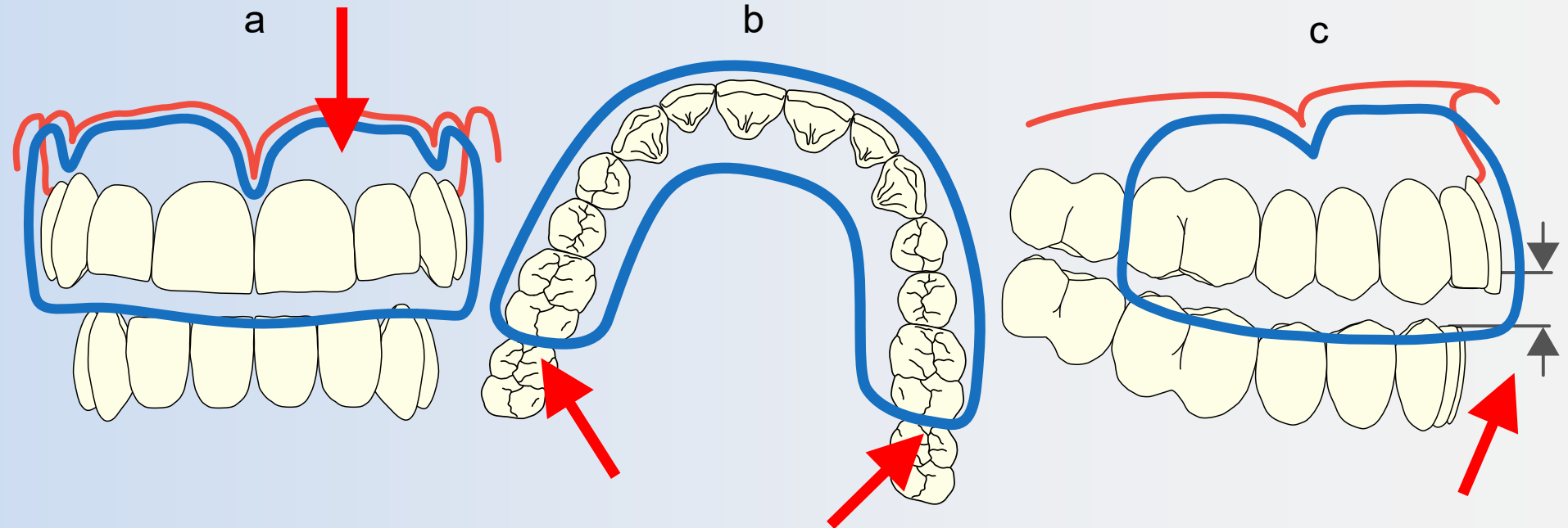

Playsafe sports-mouthguards

Why laminate?

Incisal thinning can be reduced by laminating.

The incisal thickness will increase up to 30 % when using two 2-mm foils, one after the other, instead of one 4-mm sheet.

This effect will reinforce the guard by approx. 20 %.

Prelaminated materials behave during thermoforming as single layer foils. The incisal thickness will not improve.

It is different with the prelaminated **Playsafe triple**. Thanks to a special production step, the incisal thickness will improve.

PLAY SAFE[®]

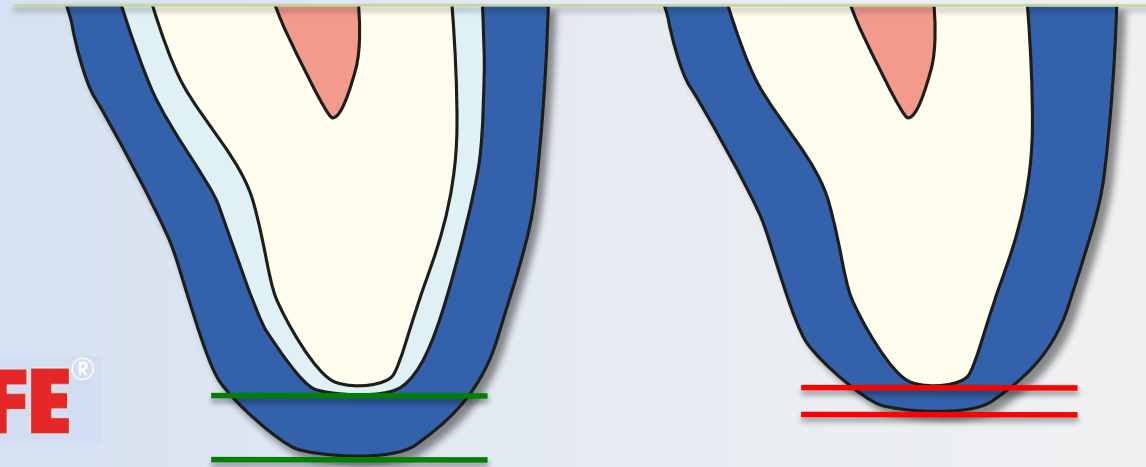

one 2 mm and one 4 mm foil

one 4 mm foil

PLAY SAFE[®] *triple*

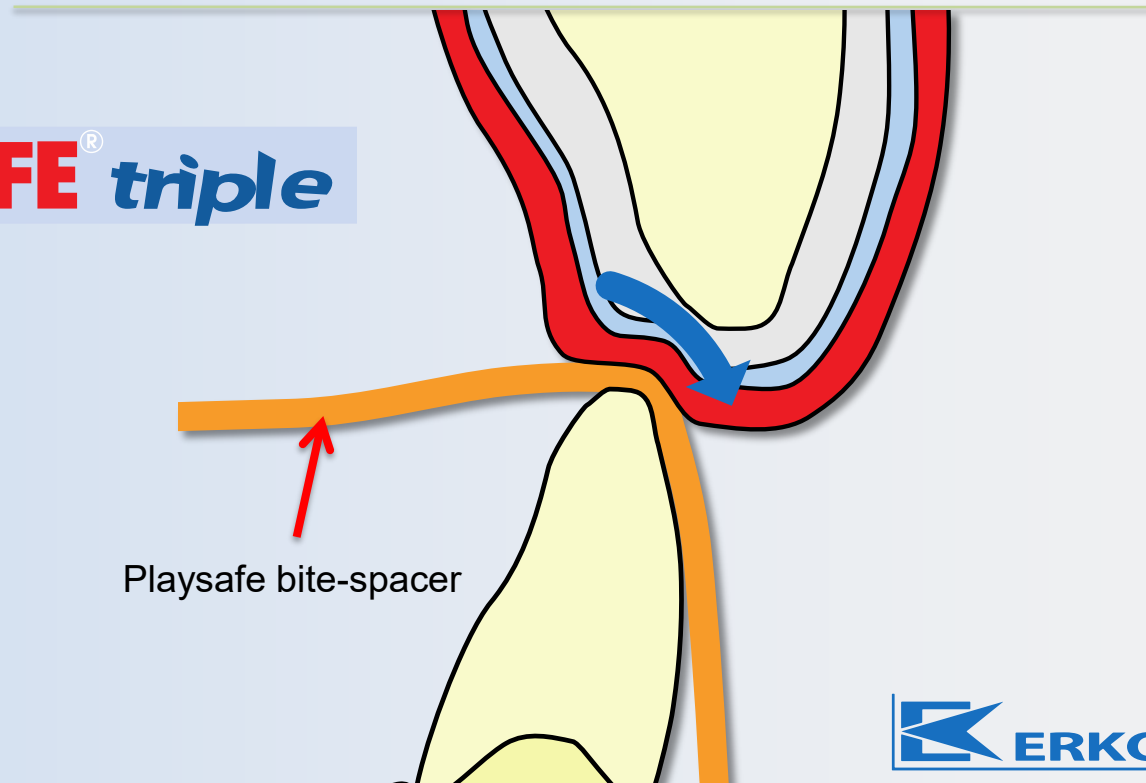

Playsafe bite-spacer

Playsafe sports-mouthguards

Testing:

Deforming load (10 N), this test measures the resistance against deformation (a).

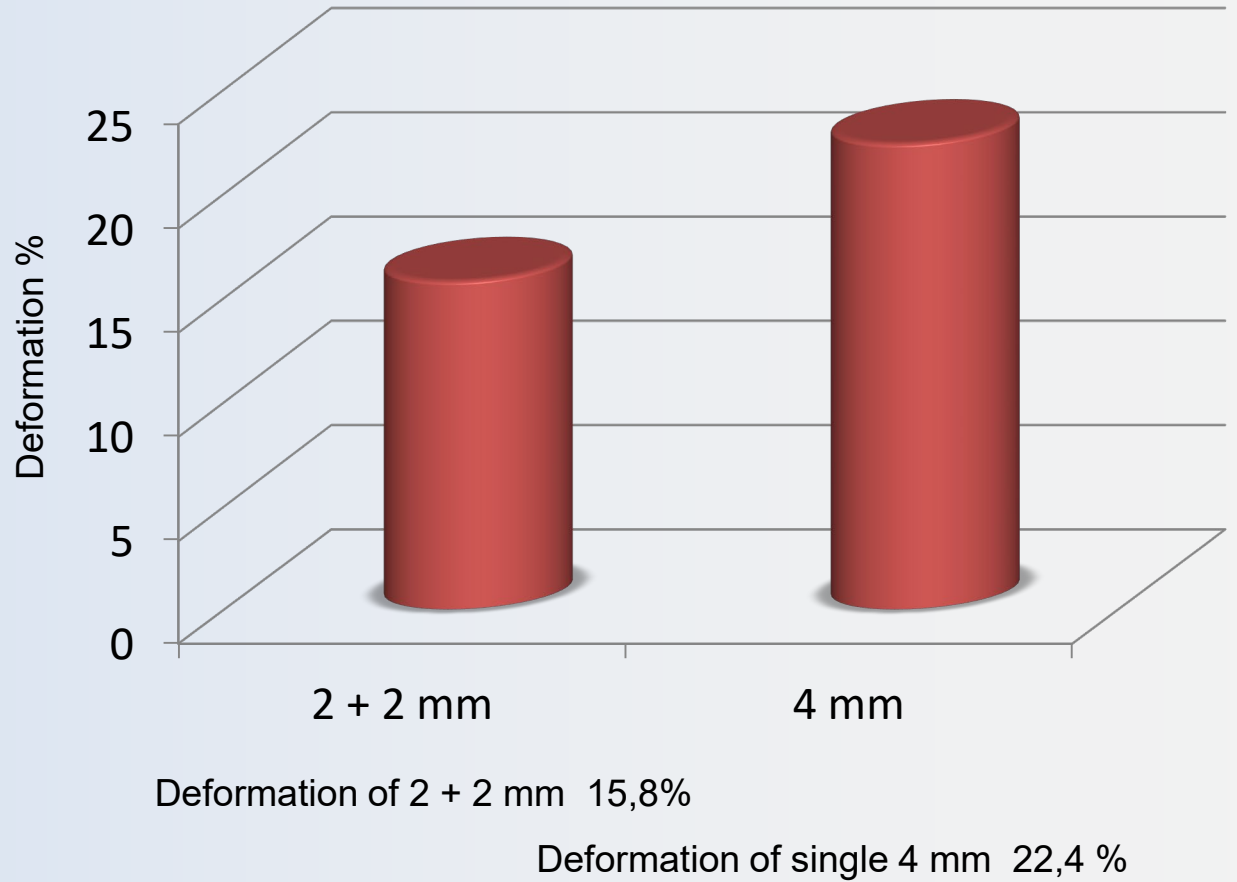
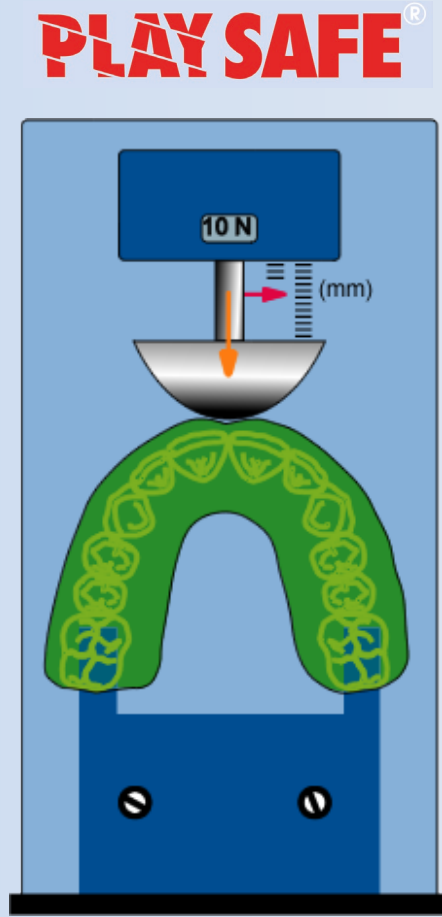

Playsafe types:



Playsafe light

Playsafe medium

Playsafe light, 2 layers

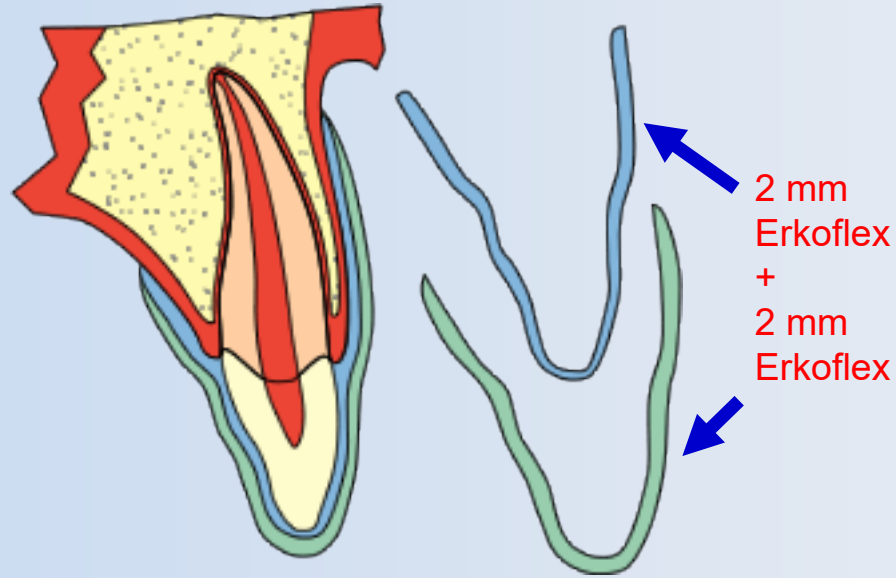

Interdental collision protection for sport activities where integral helmets are worn (f. ex. motocross). Alternatively to Playsafe medium in case of cramped oral situation. Light can be reinforced with a hard layer (see next page).

Playsafe medium, 2 layers

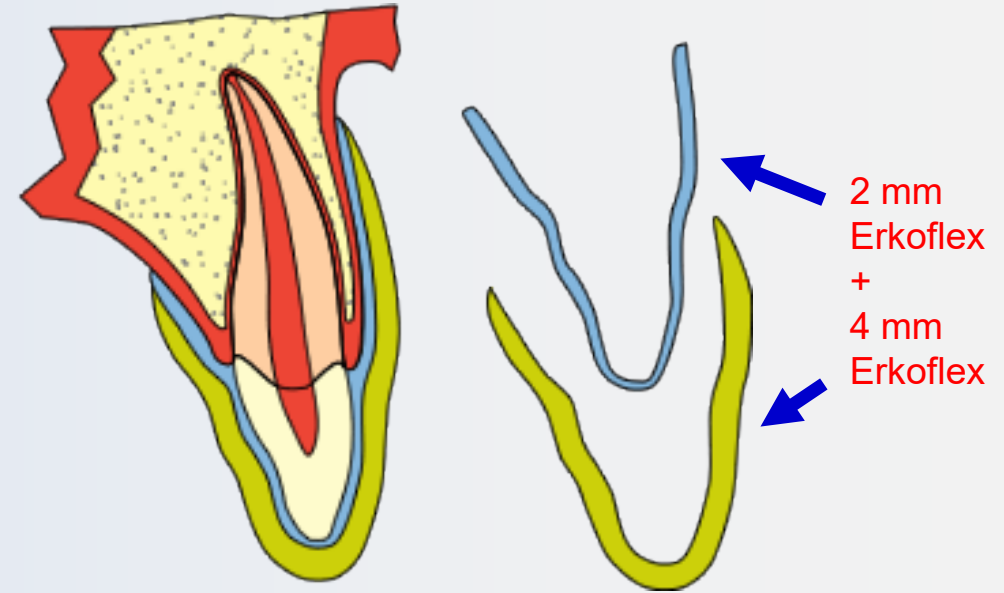

Boxing, judo, wrestling, soccer...

Prevents collisions with wider surface (boxing gloves).

Playsafe types:



Playsafe heavy-pro

Playsafe light-pro

Playsafe heavy-pro and Playsafe light-pro, 3 layers

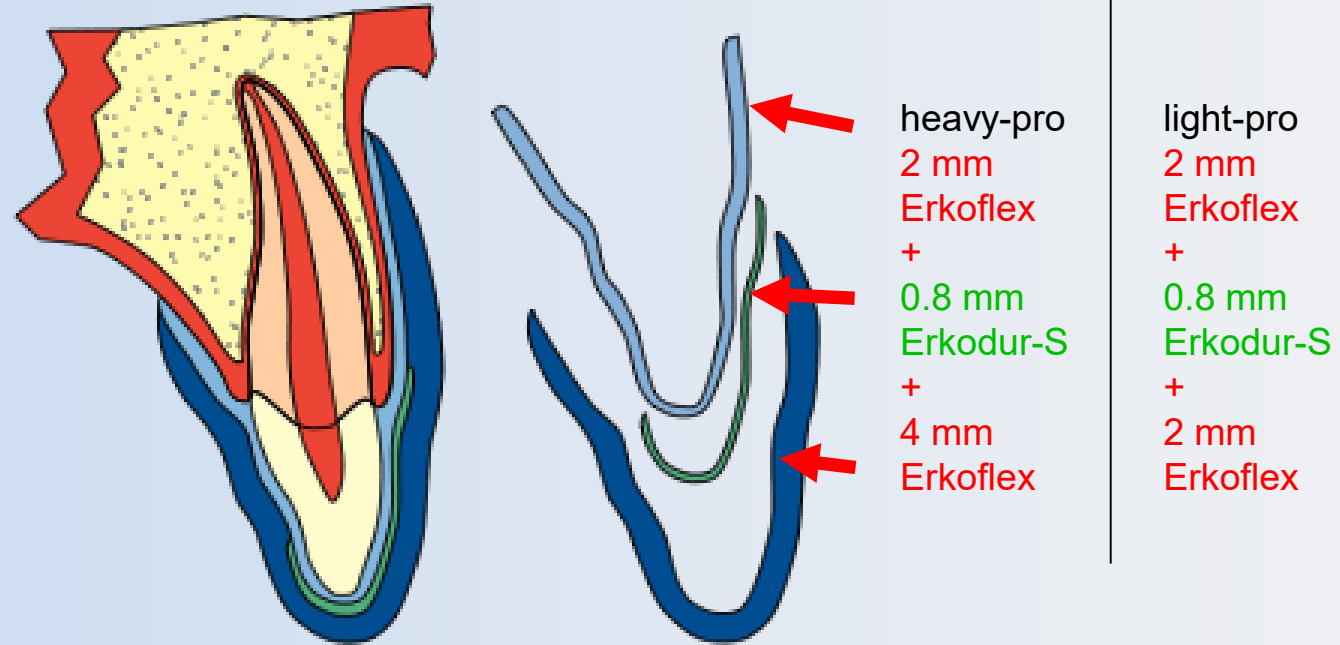

Ice hockey, field hockey, squash, kickboxing. Prevents hard collisions with small surface (rackets). Highest power distribution rate.

Recommendation:

Playsafe light-pro in case of cramped oral situation (f. ex. adolescents, ladies)

Playsafe types:

PLAY SAFE[®] triple

The Playsafe triple plate is already three-layered, outside soft and in between hard.
Available in two thicknesses:
Playsafe triple, 5.5 mm
Playsafe triple-light, 4.1 mm

Thermoform once and imprint the articulation surface in a tricky way, allow to cool off and elaborate, if desired, also apply the label, finished.

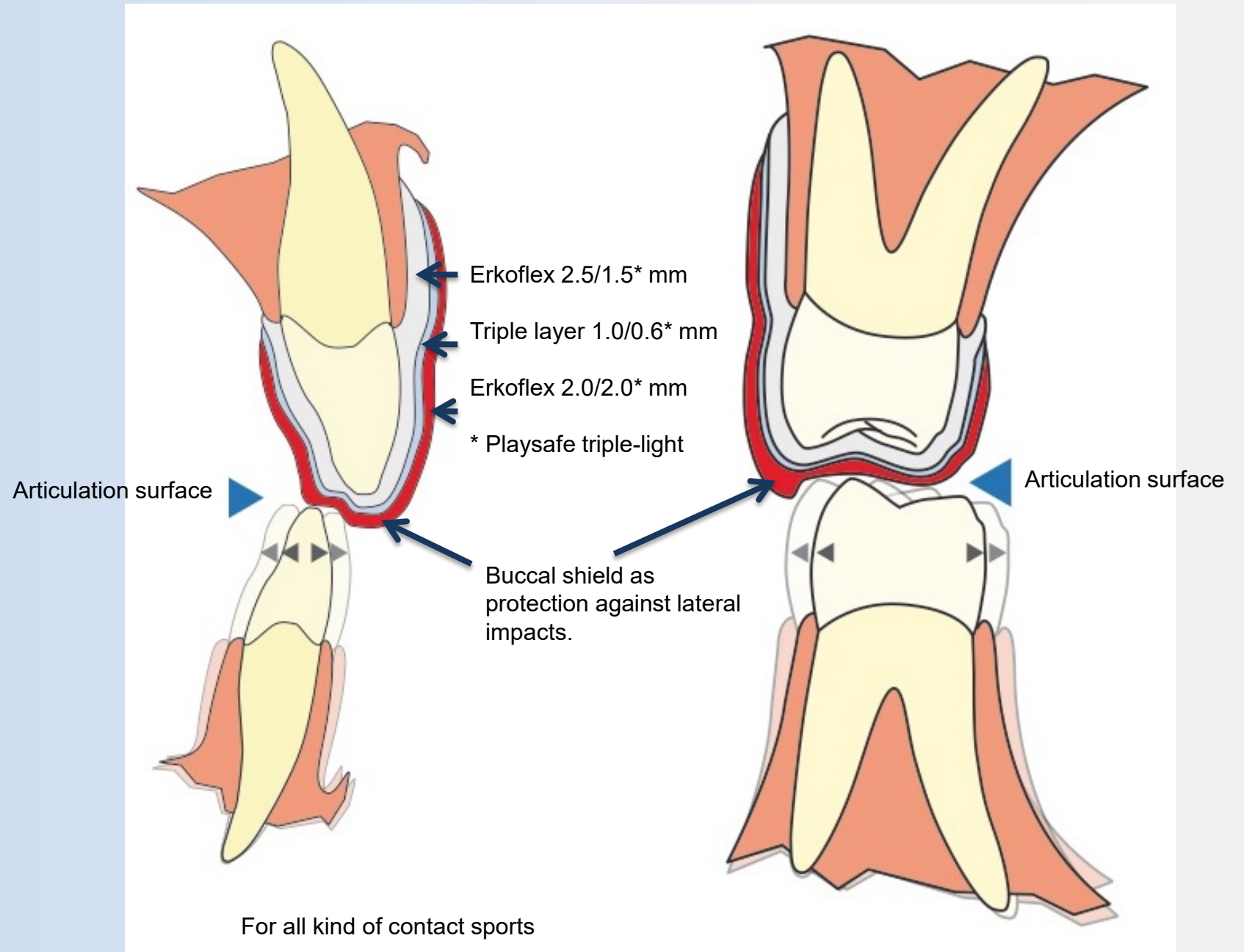

Playsafe sports-mouthguards

Testing:

Pendulum test (various weights), this test measures absorption and power distribution (%) as well as the travelling of the power through the dental arch.

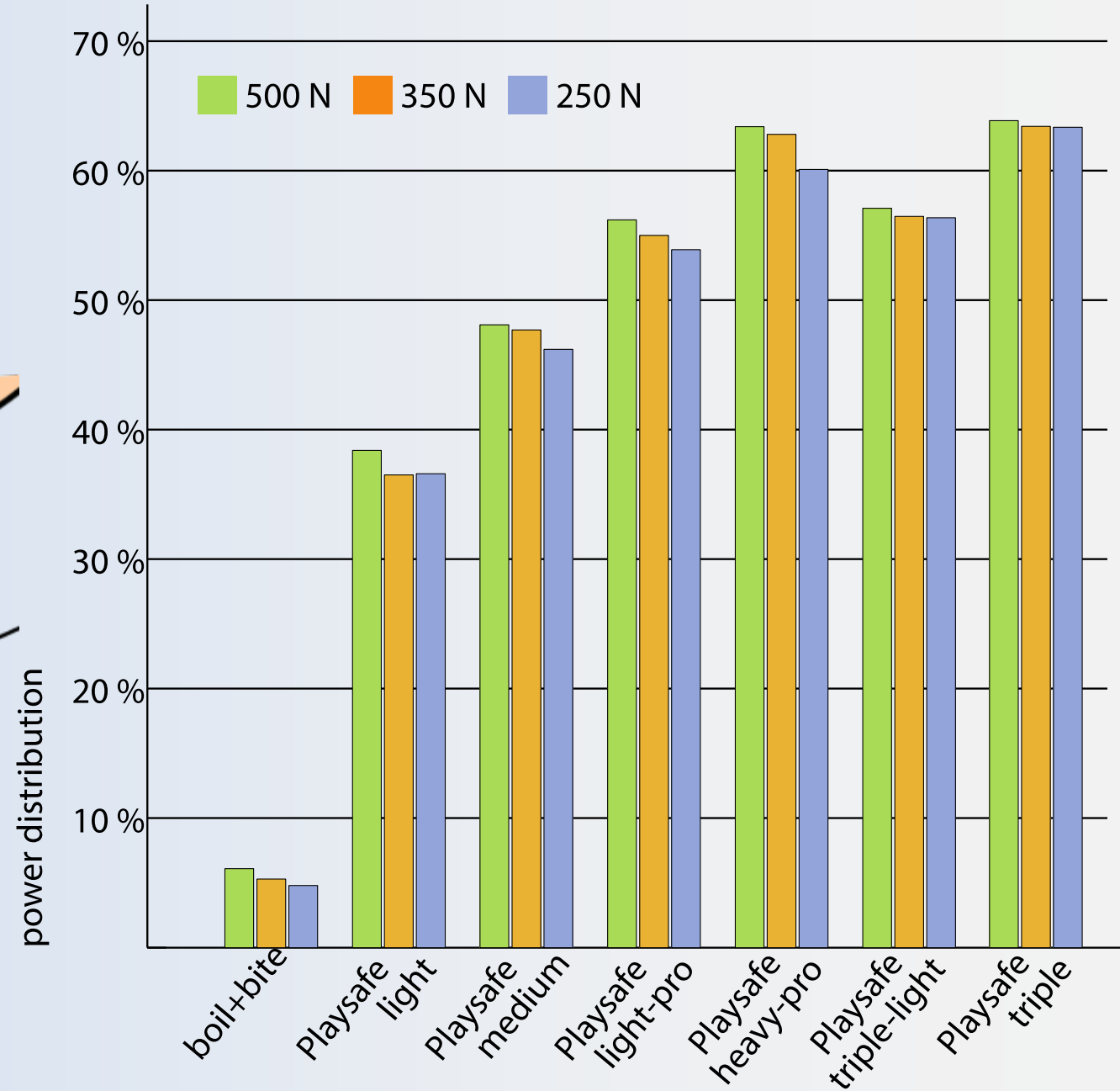
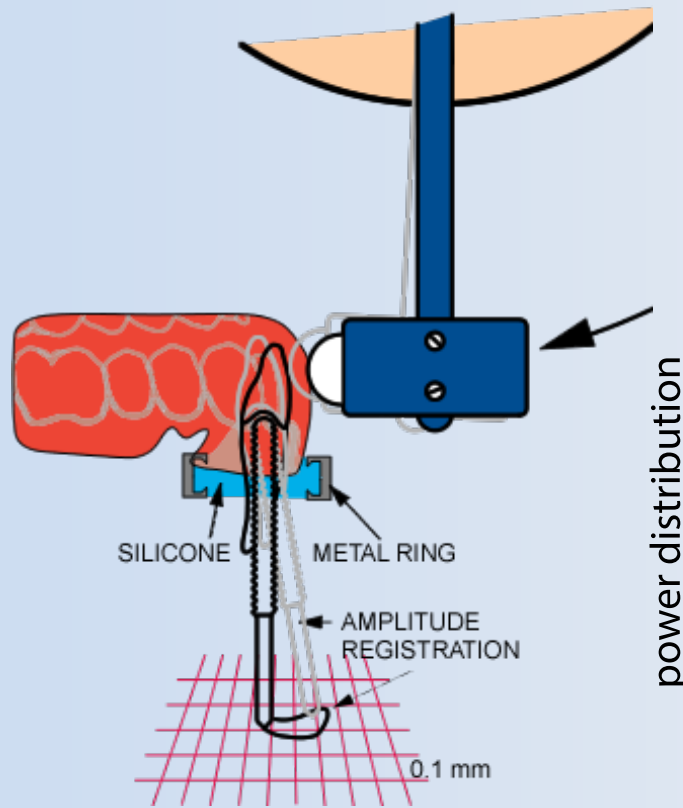

Playsafe sports-mouthguards

Testing:

Pendulum test and high speed camera.

Artificial teeth in soft silicone without significant resistance. Thus, a statement about power distribution and deformation can be made.

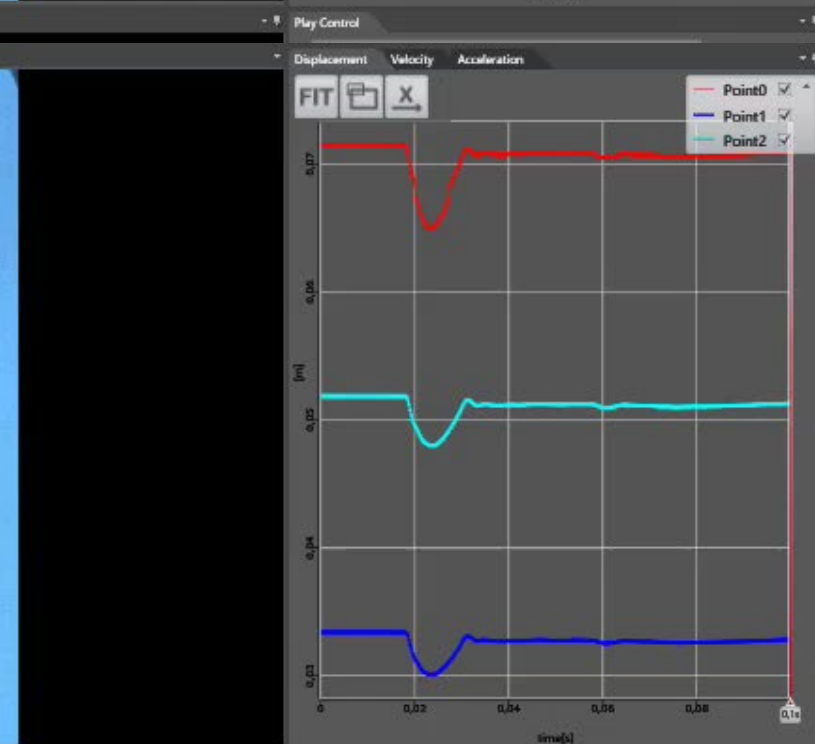
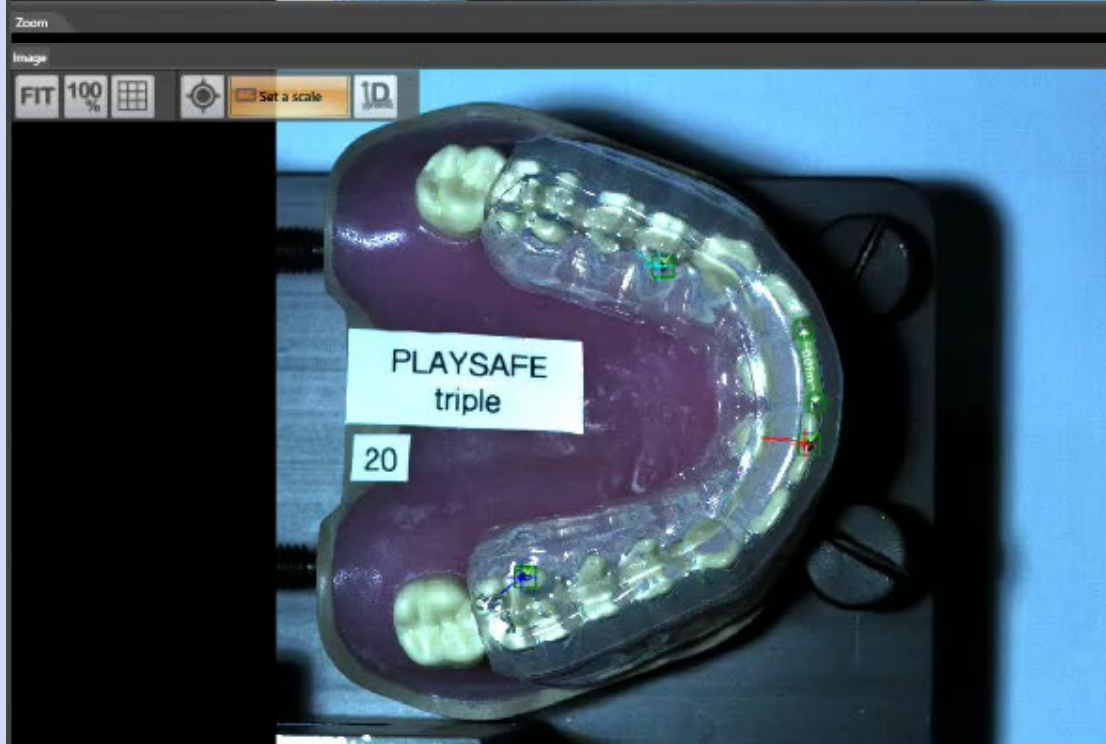
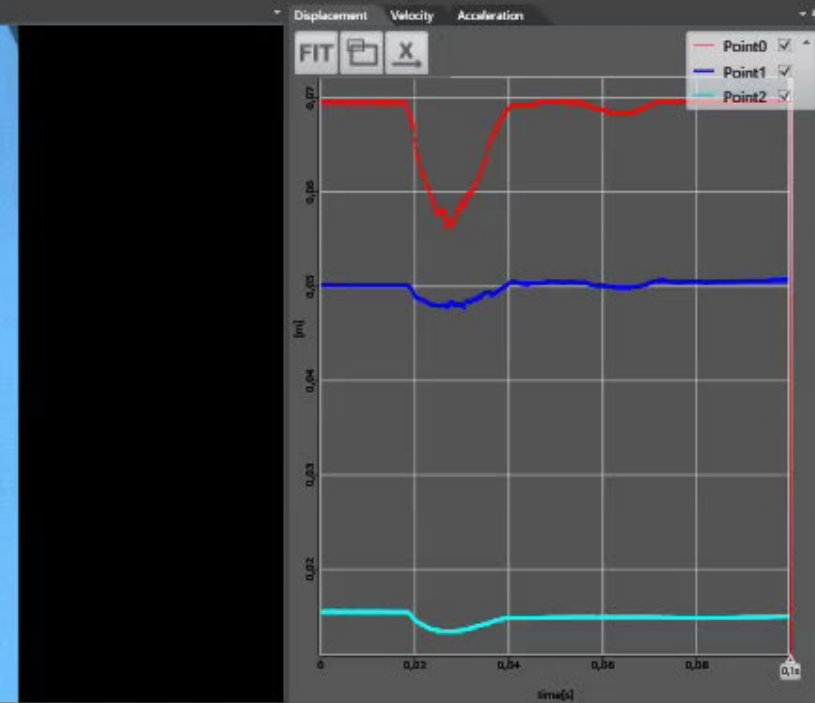
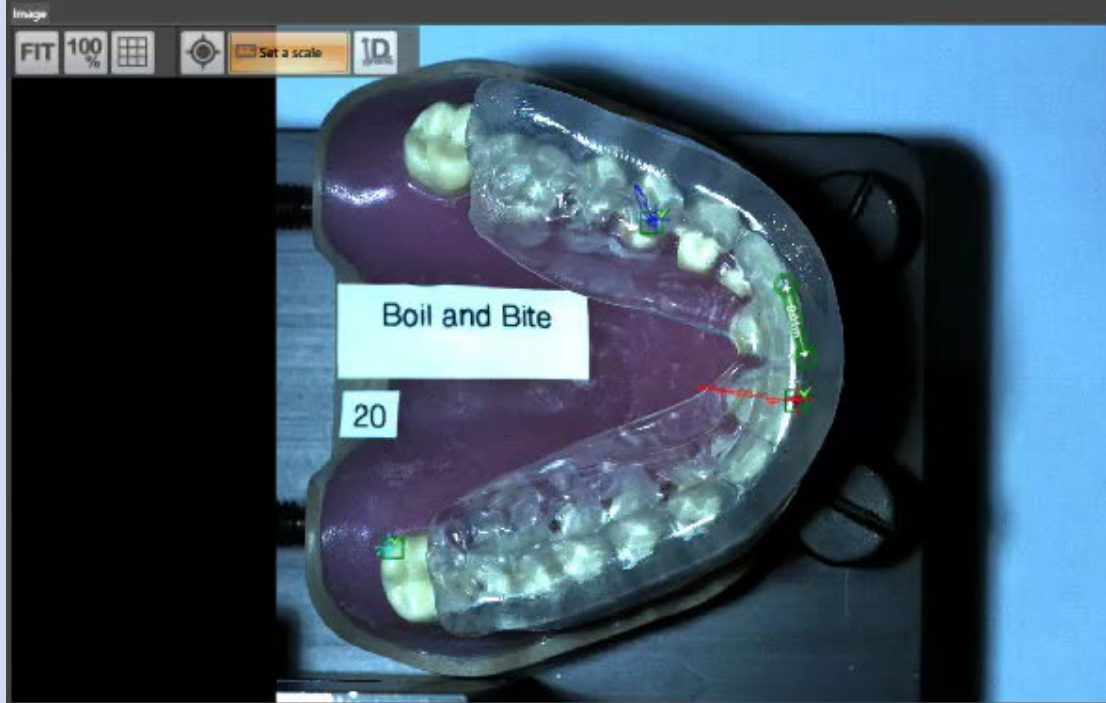

Playsafe sports-mouthguards

Testing:

Retention test shows if the mouthguard has enough retention to fit safely.

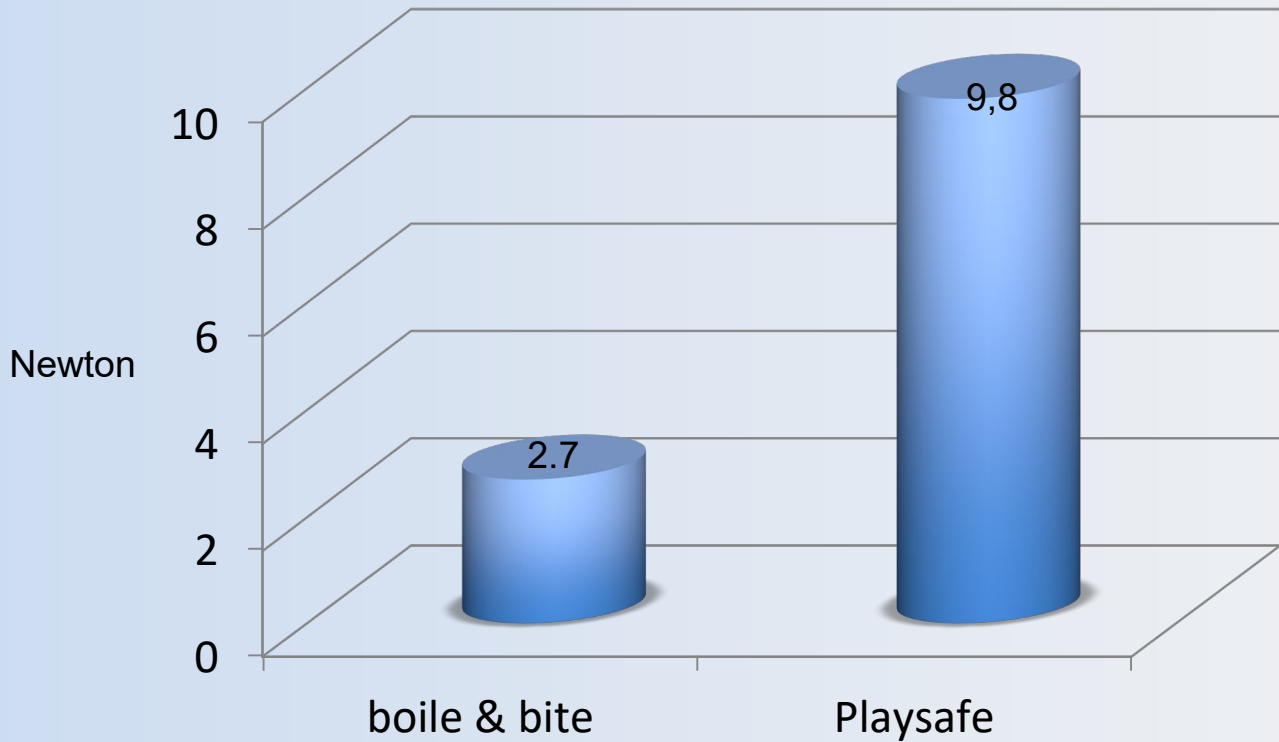

Playsafe when wearing brackets?

For a short time of wearing Playsafe may also be fabricated on brackets.

Only Playsafe, not Playsafe triple.

1. Impression taking without wiring
2. Repair model in the area of the brackets
3. Block brackets and wire with Erkogum
4. Fabricate Playsafe, integrate heavy-pro reinforcement palatinal

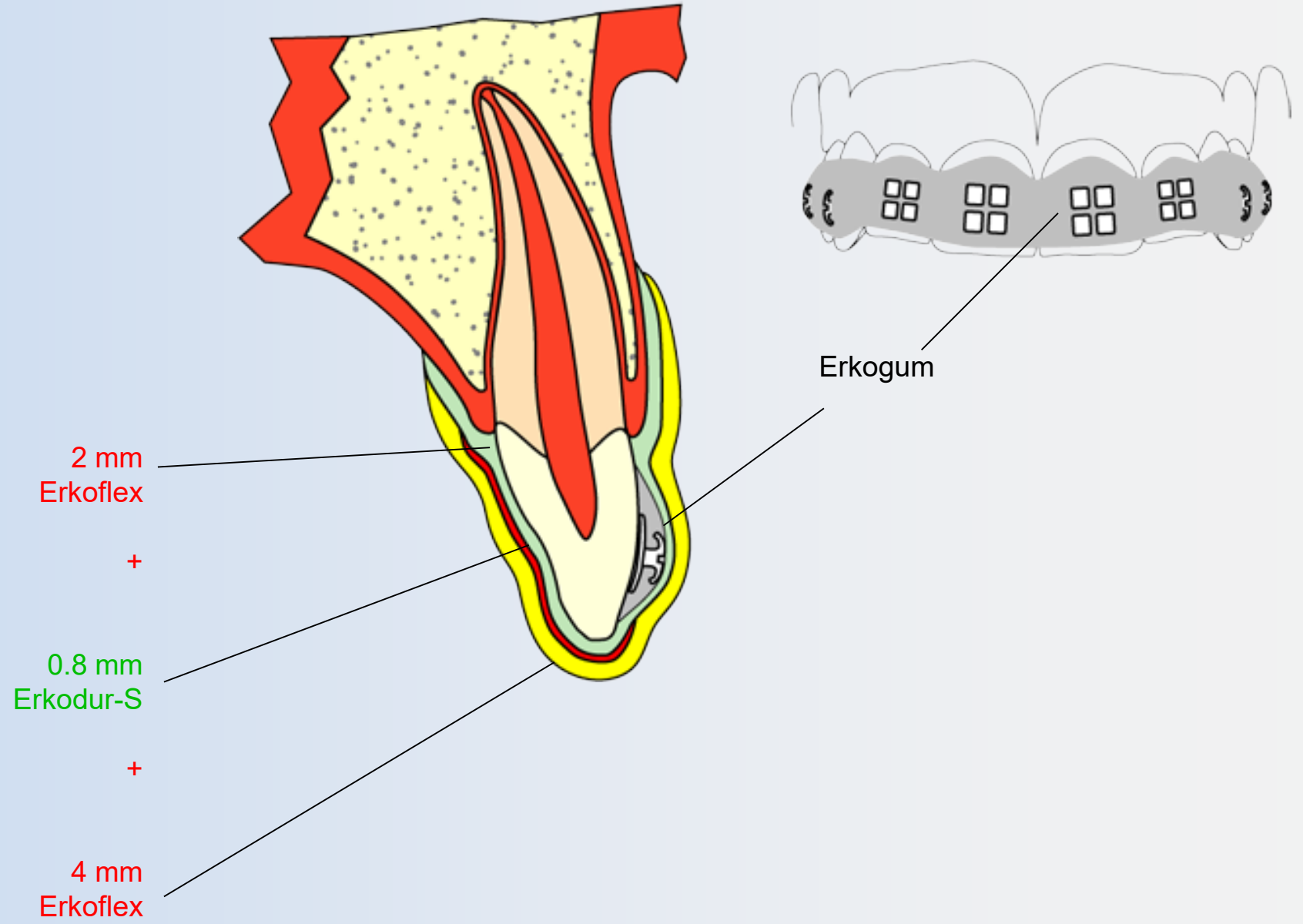

Playsafe sports-mouthguards

Playsafe mouthguards fulfill all requirements to the highest class of mouthguards.

Highest load absorption and distribution, lowest risk of ingestion, precise fit. Ultimate protection of middle face injuries, helps to prevent neck injuries and concussion.

Comfortable to wear, easy to speak and breathe.

Playsafe and Playsafe triple mouthguards can be manufactured in a lot of different colours.

15 plain colours and 10 freestyle colours are available for each Playsafe type.

In addition it is possible to fabricate a 2-, 3- or 4-coloured mouthguard out of the colours 1-15.

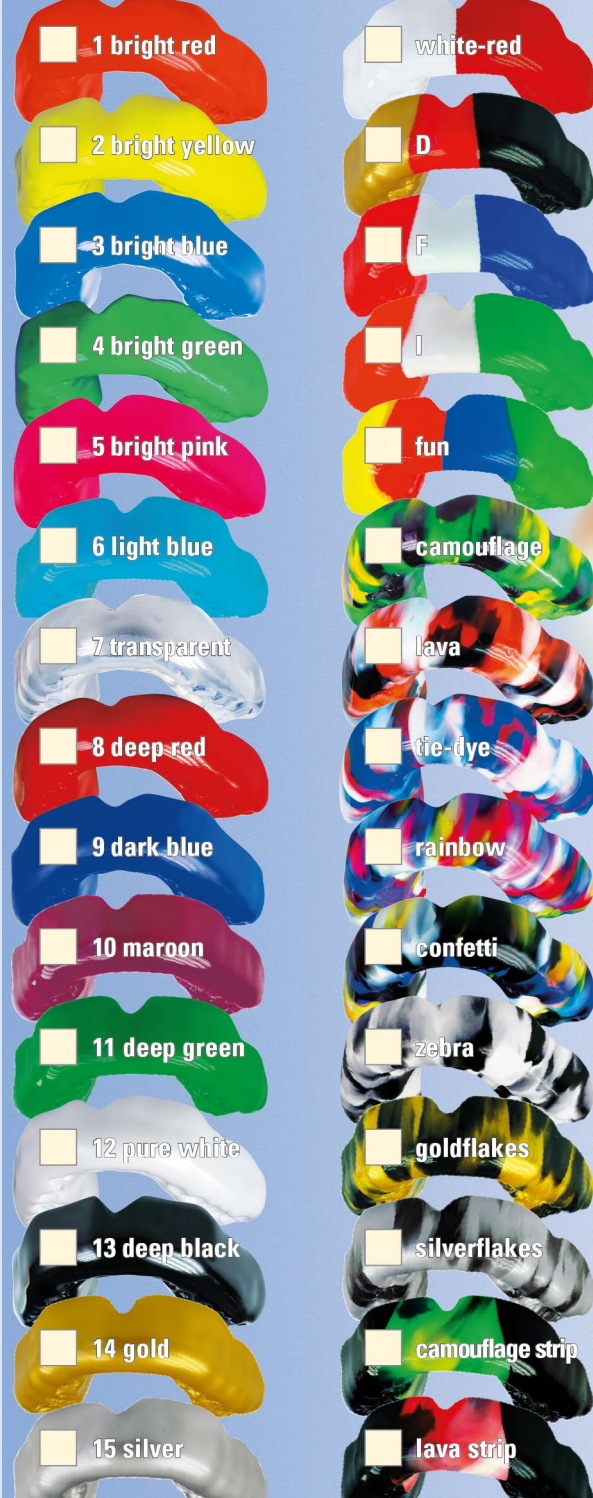

PLAYSAFE[®]

PLAYSAFE[®] triple

2-, 3- or 4-coloured sports-mouthguards

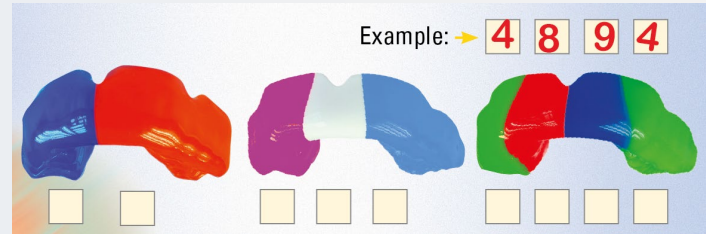



PLAY SAFE® triple

Playsafe triple

Comparison of Playsafe triple and Playsafe heavy-pro



Playsafe heavy-pro

PLAY SAFE®

Structure of Playsafe triple:

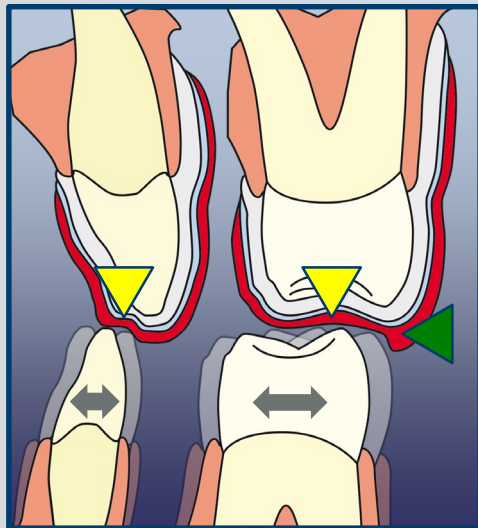

Thermoform once a Playsafe triple foil and get the buccal shield ◀ as protection against lateral impacts and an articulation surface ▼ for comfortable freedom ↔ for the lower jaw.

Playsafe triple foil 5.5 mm, prelaminated:

Erkoflex 2.5 mm, soft. • *Triple layer 1.0 mm, hard • Erkoflex 2.0 mm, soft

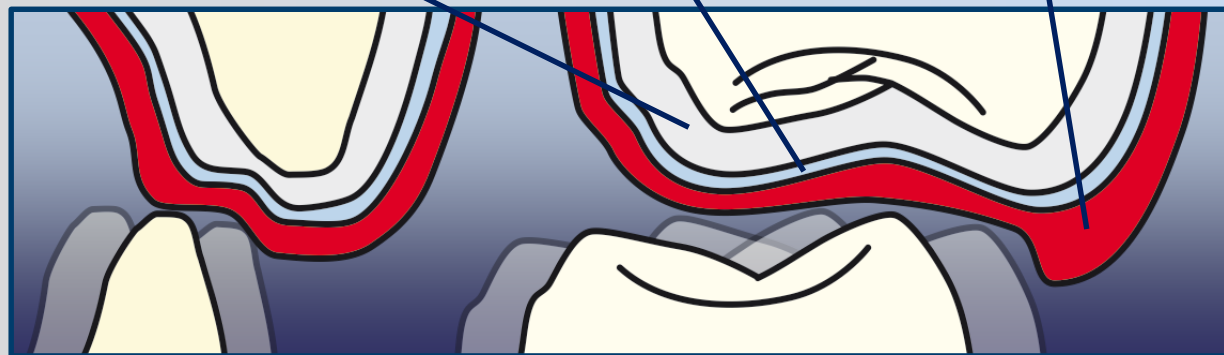

*Triple layer, COC (cyclo-olefin-copolymer)

Structure of Playsafe heavy-pro:

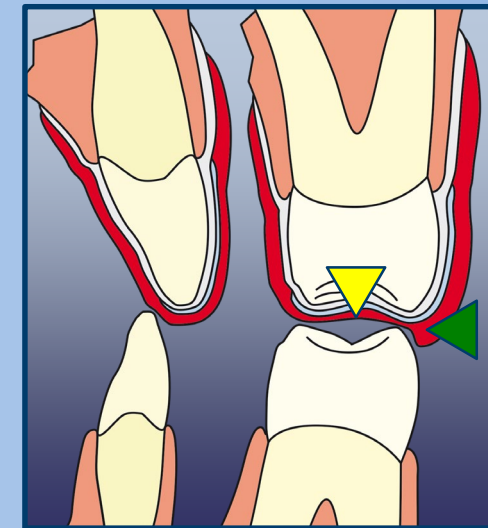

Thermoform one layer after the other.
 First Erkoflex 2.0 mm, soft,
 second Erkodur-S 0.8 mm, hard,
 third Erkoflex 4.0 mm, soft.
 The buccal shield ◀ and the articulation surface ▼ is ground afterwards.

Playsafe heavy-pro total foil thickness 6.8 mm

Erkoflex 2.0 mm, soft • Erkodur-S 0.8 mm, hard. • Erkoflex 4.0 mm, soft

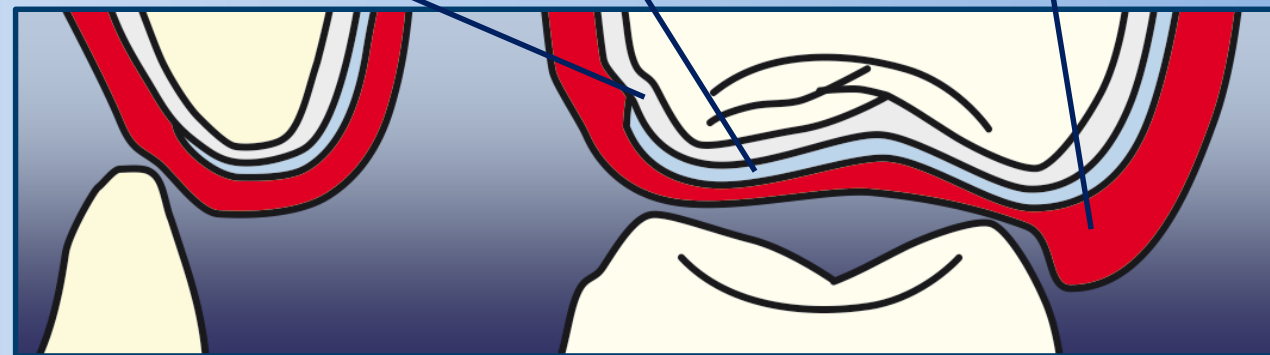

Comparison of weight, volume and incisal thickness at tooth 21

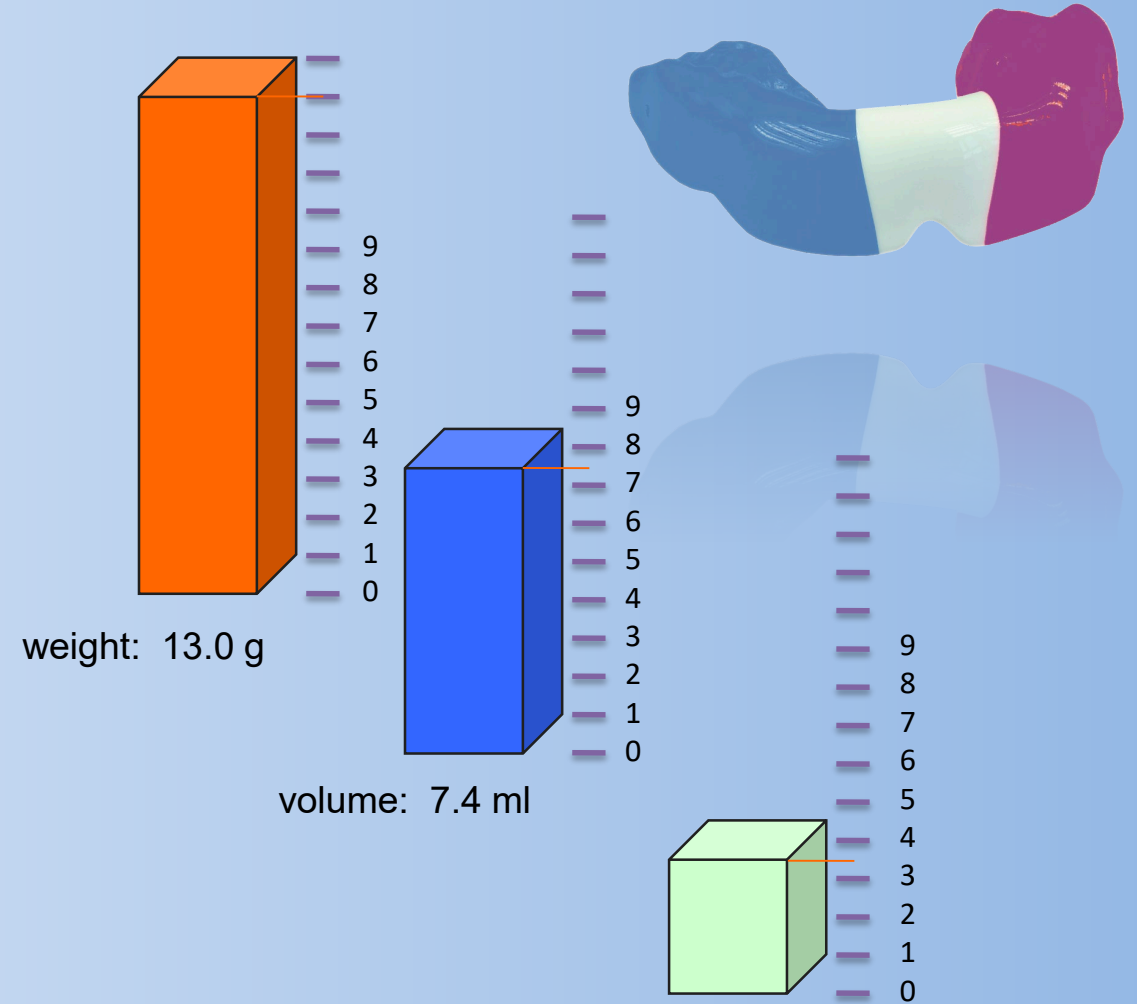
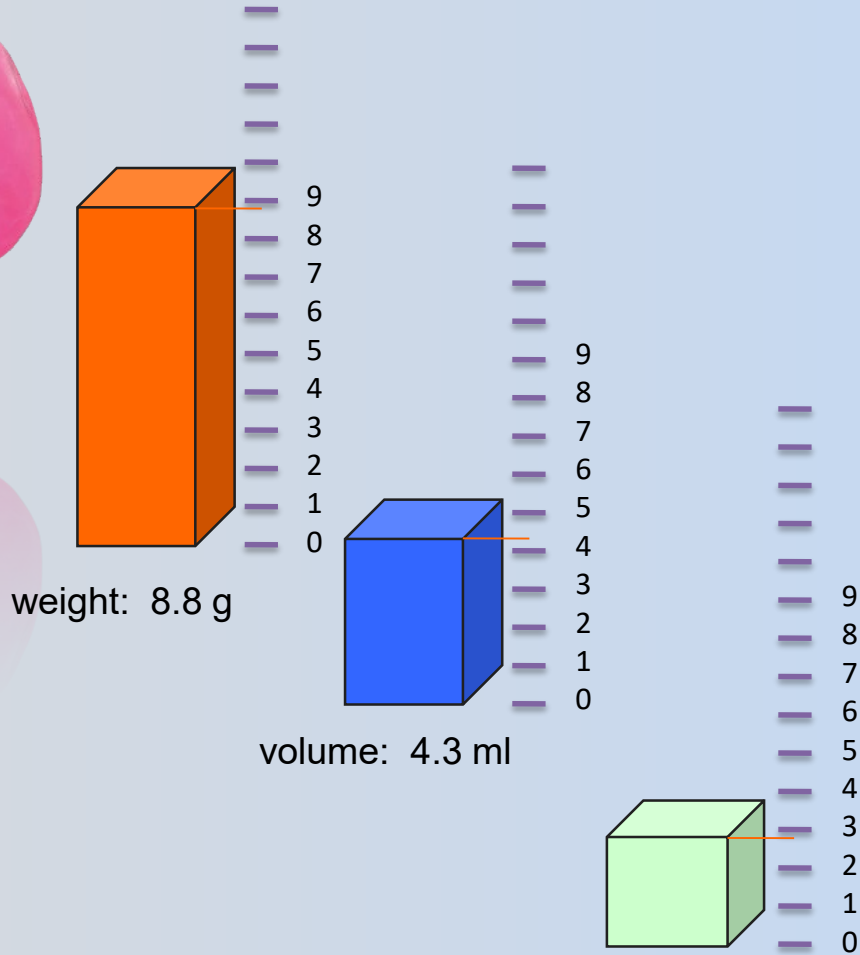

Comparison of deformation of 1.25 and 2.0 mm

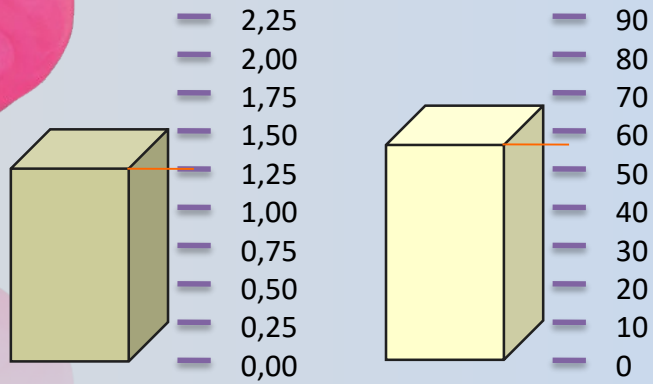

Deformation 1.25 mm • Power 57 N

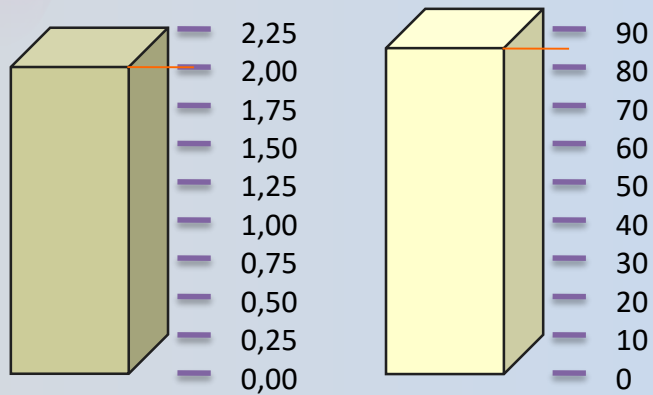

Deformation 2.0 mm • Power 85 N

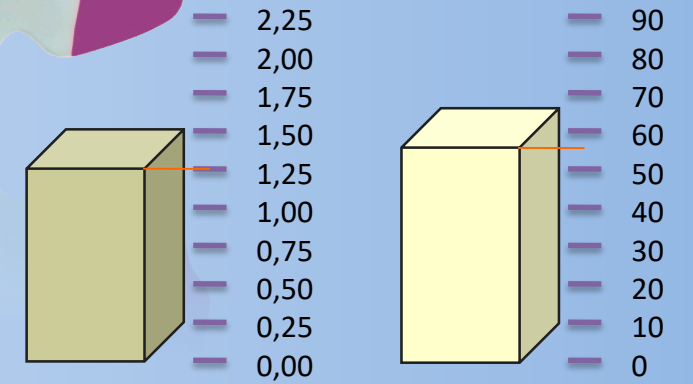
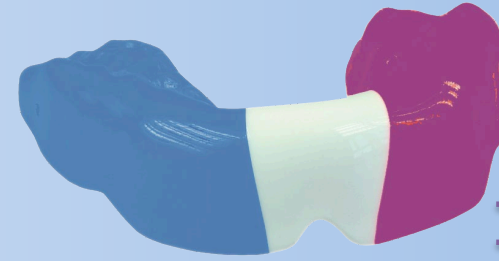
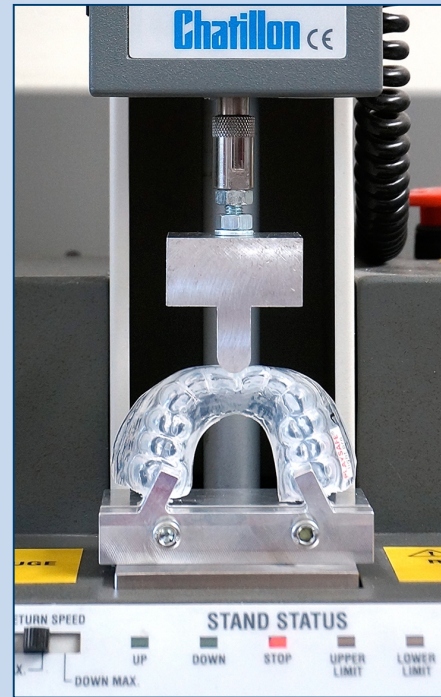

Deformation 1.25 mm • Power 56 N

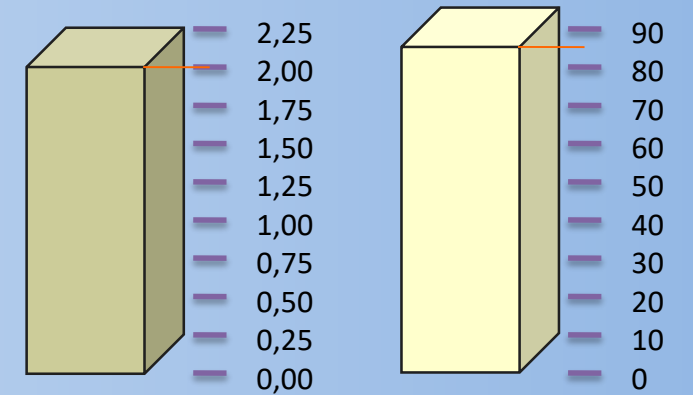

Deformation 2.0 mm • Power 86 N

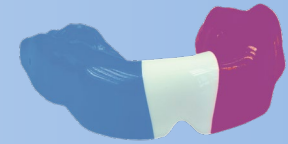
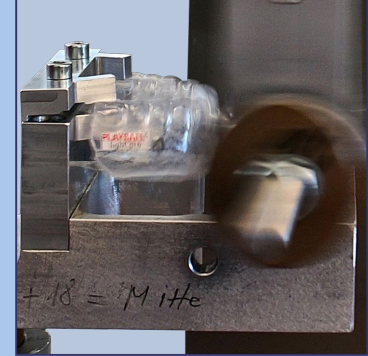
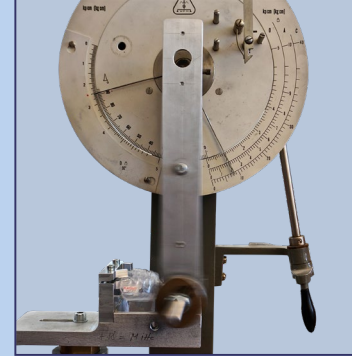
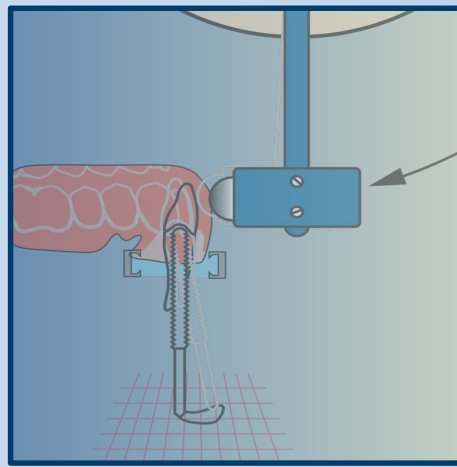
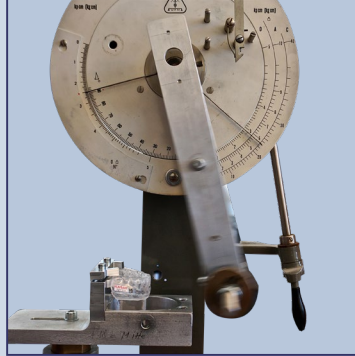
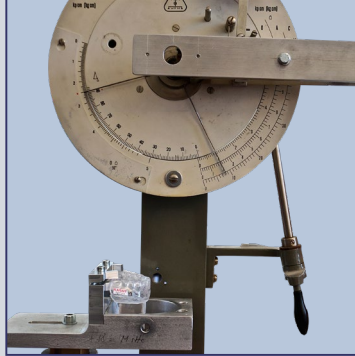

The pendulum test measures the deformation at the teeth 21, 24 and 26. Power distribution and absorption can be calculated.

Comparison of deformation teeth 21, 24, 26
Ø of several measurements

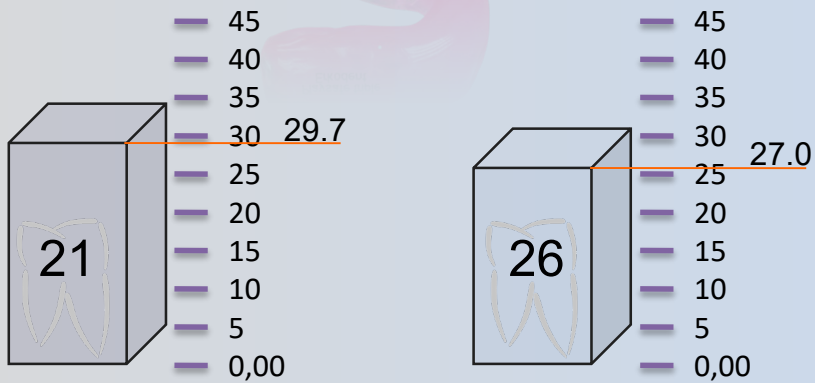

Deformation in mm* • Pendulum weight 1.5 Nm (637 g)

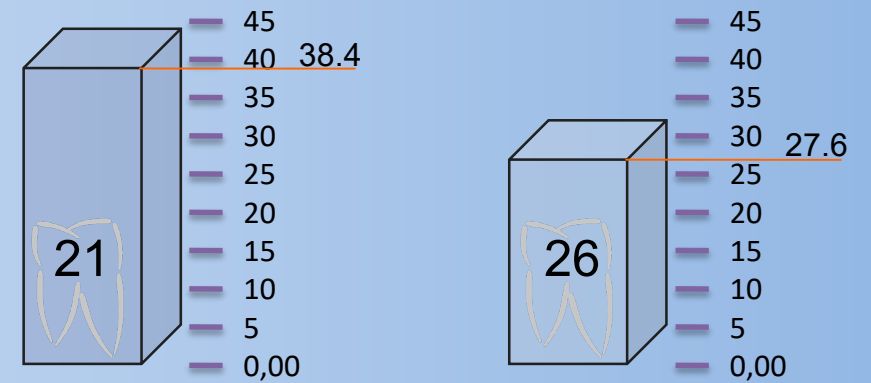

Deformation in mm* • Pendulum weight 1.5 Nm (637 g)

* to better distinguish the deflections were multiplied by virtual extension of the roots.

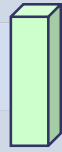

Comparison summary

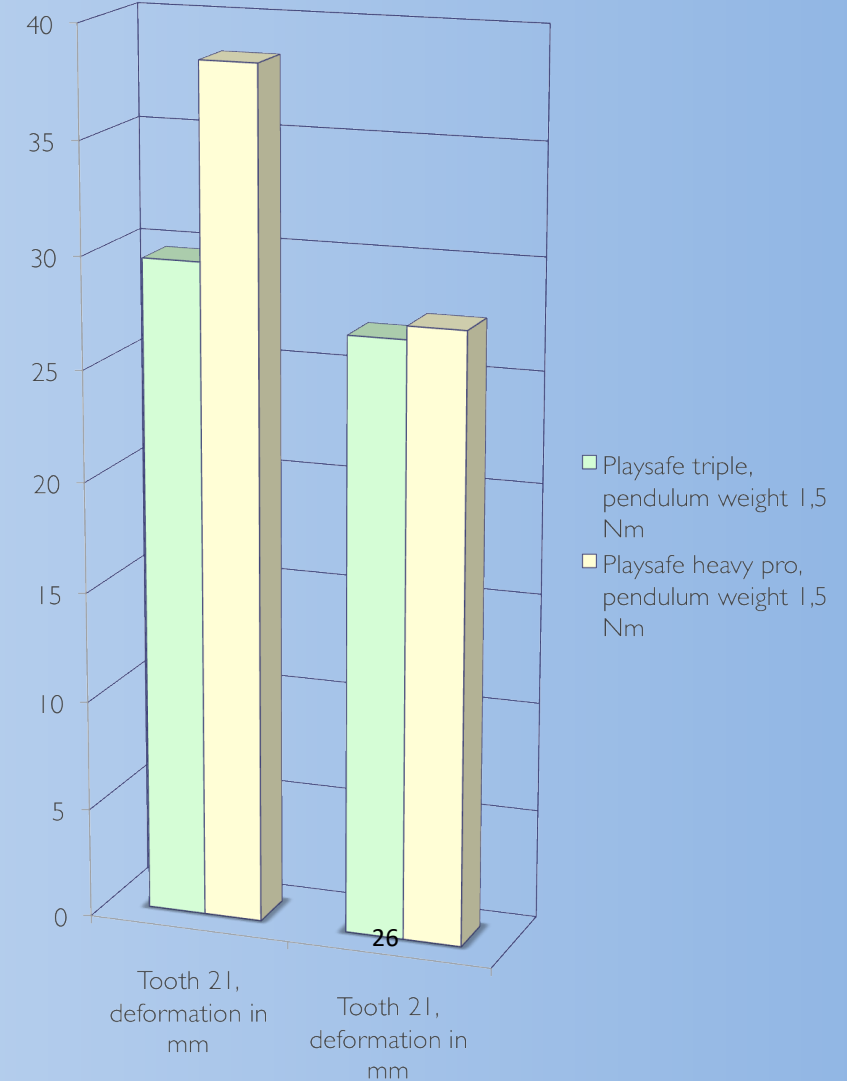
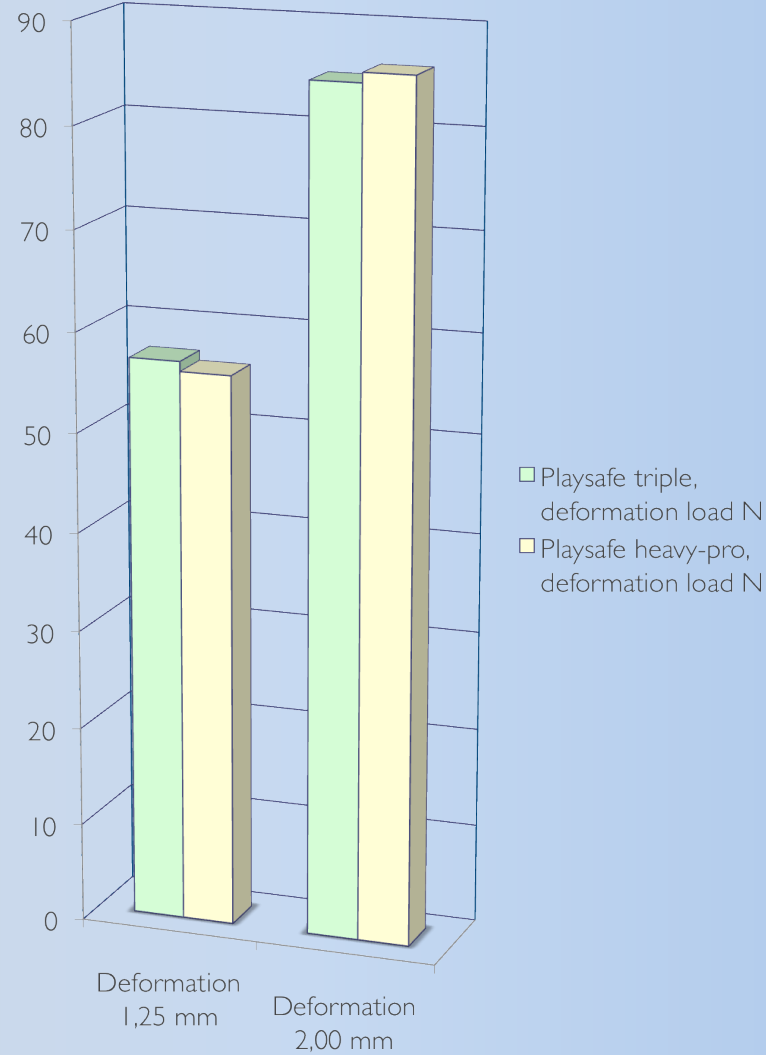
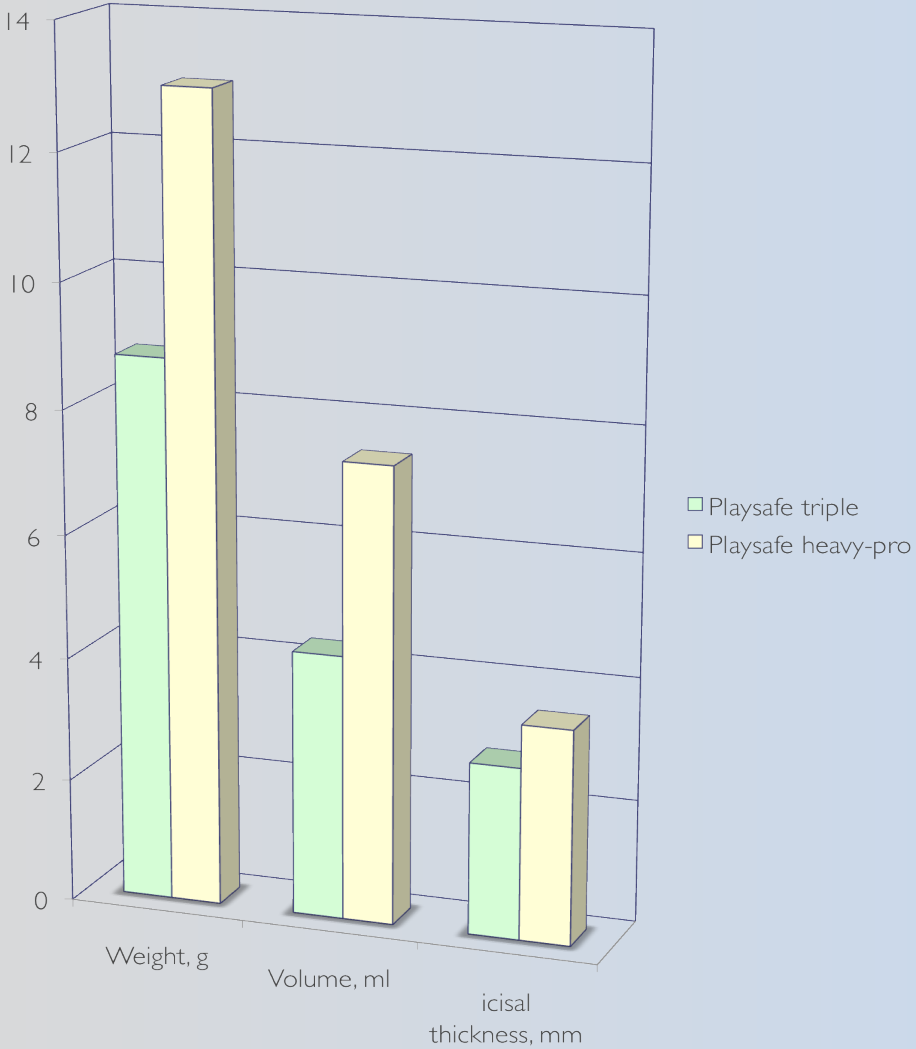

Playsafe
sports-mouthguards

PLAY SAFE[®]

PLAY SAFE[®] triple

Thank you very much
for your attention

